

1990's

Medium voltage drive & traction CEGELEC, ALSTOM, GEC ALSTHOM

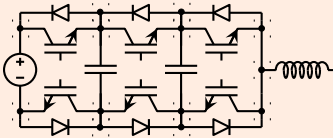

Patent FR2679715 "Dispositif électronique de conversion d'énergie électrique", 25 July 1991
T. MEYNARD, H. FOCH

LEEI, CNRS, INPT

CEGELEC



4.7kV DC bus, liquid-cooled
3-phase VSI for MV drive
3-cell, 3.3kV IGBTs

ALSTOM



6kV DC bus, air-cooled
3-phase VSI for MV drive
3-cell, 4.5kV IGBTs at 900Hz

GEC ALSTHOM



3kV DC bus (4.5kV DC max)
4x 1.5MW DC choppers
2-cell, 4.5kV GTOs

2000's

Some industrial applications of multilevel converters

Medium voltage drive - ABB

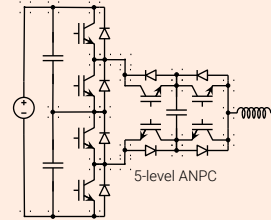

Patent US2007025126 "Converter circuit for connecting a plurality of switching voltage levels"
P. BARBOSA, J. STEINKE, P. STEIMER, L. MEYSENC, T. MEYNARD

ABB

ABB



10kV DC bus, 3-phase VSI for medium voltage drive application, 5-level ANPC in each phase

AC/AC chopper - CIRTEM

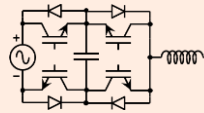

Patent FR2814006 "Dispositif de conversion d'énergie électrique à découpage", 12 September 2000
T. MEYNARD, E. LEFEUVRE

LEEI, CNRS, INPT

CIRTEM



240V AC
3 & 6kW
2-cell, 600V IGBTs

2010's

Flywheel high speed drive - CIRTEM



650V DC bus
6kW, $\eta > 99.3\%$
12-cell, 100V MOSFETs

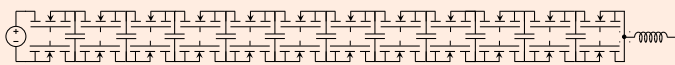

"Development of Multi-Level Converters: a SME's approach", D. FERRER
ECPE Workshop 'Advanced Multicell / Multilevel Power Converters', 1 - 2 July 2014, Toulouse, France

Medium voltage drive application GENERAL ELECTRIC

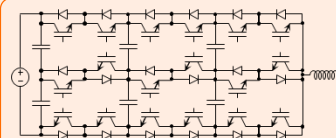

Patent FR2809548 "Dispositif de conversion d'énergie multicellulaire", 26 May 2000
T. MEYNARD, H. FOCH, G. GATEAU

LEEI, CNRS, INPT

GENERAL ELECTRIC



10kV DC bus
3-phase VSI for MV drive
2x2-cell (Stacked Multi Cell) each phase

Medium voltage drive application - MEIDENSHA

MEIDENSHA



11kV DC bus, 1MVA
 $\eta > 98\%$ ("industry leader")
IGBTs, 5-level each phase

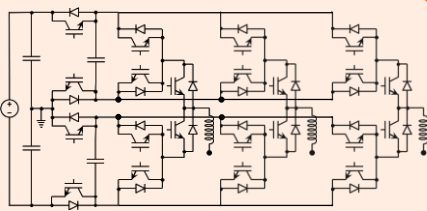

"A multilevel converter topology with common flying capacitors" H. ZHANG, W. YAN, K. OGURA, S. URUSHIBATA
In Energy Conversion Congress and Exposition

Embedded application

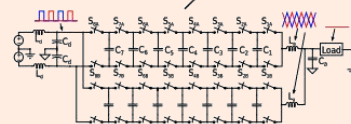
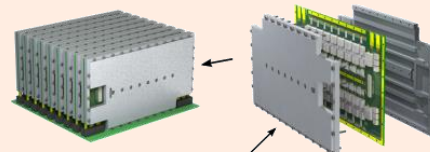

"Design of a GaN-based, 9-level flying capacitor multilevel inverter with low inductance layout"
R. C. PILAWA-PODGURSKI et al.

UNIVERSITY OF ILLINOIS AT URBANA-CHAMPAIGN, URBANA, ILLINOIS

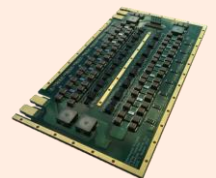

1000V DC bus
20kW, $\eta > 99\%$
2x8-cell, 200V GaN FETs

PV inverter - SOLAREEDGE

SOLAREEDGE



400V DC - 240V AC
3 to 7.6kVA, $\eta_{max} = 99.5\%$
(first ever to reach 99% CEC efficiency rating)
Si MOSFETs, 4-level each phase

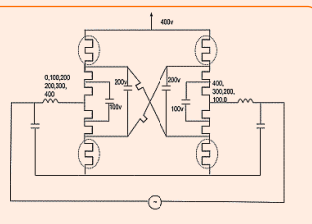

UPS - APC-MGE by Schneider Electric

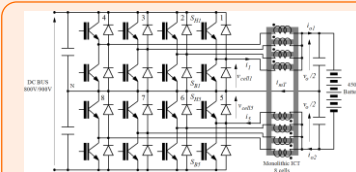

"Design and characterization of an eight-phase-137-kW intercell transformer dedicated to multicell DC-DC stages in a modular UPS"
F. FOREST, T. MEYNARD, J. HUSELSTEIN, D. FLUMIAN, C. RIZET, A. LACARNOY

IES, CNRS, UM2
LAPLACE, CNRS, INPT
APC-MGE BY SCHNEIDER ELECTRIC

APC-MGE BY SCHNEIDER ELECTRIC



800V DC bus
137kW
8-cell coupled interleaved

2020's

Smartphone

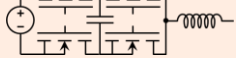
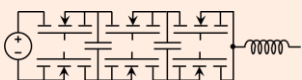

3-5V DC, 2-5W & 6-9V, 10-20W
2- or 3-cell, 5V or 2.5V MOSFETs
Market ~50.10⁹ chips/year



Series parallel multilevel converters: influence on filters (DC-DC example)

2-level

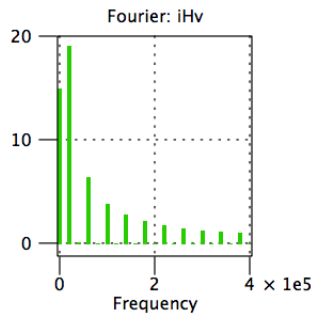

$$A_1 = \frac{2I_{LV}}{\pi} \sin(\pi D)$$

@ f_{sw}

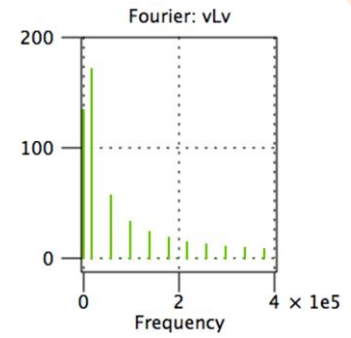
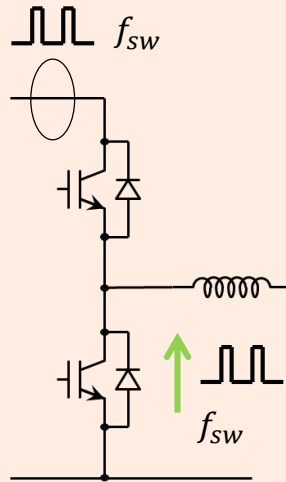

$$A_1 = \frac{2V_{HV}}{\pi} \sin(\pi D)$$

@ f_{sw}

Multilevel

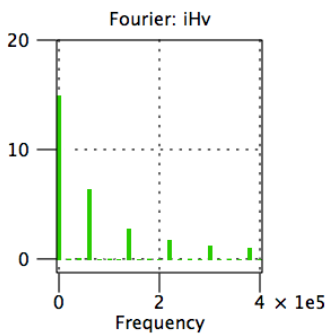

$$A_1 = \frac{2V_{HV}}{n_{par}\pi} \sin(\pi D)$$

@ $n_{par}f_{sw}$

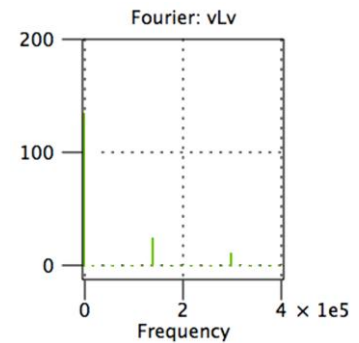
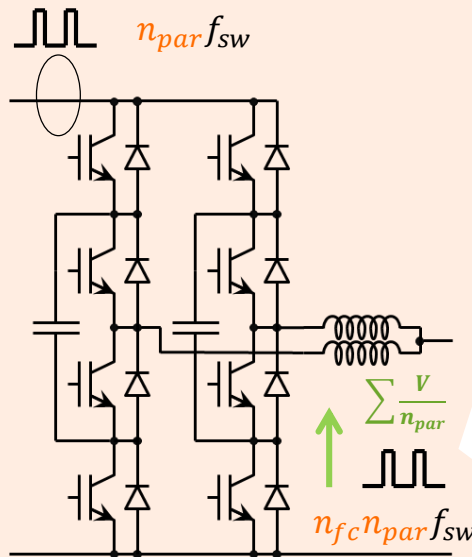

$$A_1 = \frac{2V_{HV}}{n_{fc}n_{par}\pi} \sin(\pi D)$$

@ $n_{fc}n_{par}f_{sw}$

Increased apparent switching frequencies
 Reduced amplitudes of voltage and current harmonics